

## RLS1315 / RLS1330 Barcode label scale



---

---

# Contents

Introduction.....	1
1. The hanging scale's specification.....	2
2. Standard Equipment.....	2
3. Features Summary.....	3
3.1 Unique and powerful network.....	3
3.2 Usage is easy to learn.....	3
3.3 Advanced functions and durable quality.....	3
4. Hanging Scale Installation Steps.....	4
4.1 Installation.....	4
4.2 The installation of the thermal label paper.....	5
4.3 Description of label paper.....	6
4.4 The keyboard.....	6
5. Overall Appearance.....	7
6. Common easy-to-use operations.....	8
6.1 Switch on and off.....	8
6.2 Weighing and pricing.....	8
6.3 Tare operation.....	9
6.4 Discount.....	9
6.5 Price Changing.....	9
6.5.1 Permanent Changing.....	9
6.5.2 Temporary Changing.....	10
6.6 Choosing Unit of Weight.....	10
6.7 Charging by Piece.....	10
6.8 Price Tag Printing.....	11
6.9 Quick Copy.....	11
6.10 Automatic fast packaging.....	11
6.11 Operation button in common use.....	11
7. Wireless Label Scale Setting Instruction.....	12
7.1 Network connection mode.....	12
7.2 Router set up.....	12
7.3 Hanging Scale Setting.....	12
7.4 Computer software settings.....	12
8. Function setting.....	13
8.1 Input settings of single item.....	13
8.2 System set up.....	13
8.3 Lock.....	14
9. Troubleshooting.....	15
9.1 Scales crash.....	15
9.2 Print related issues.....	16

---

9.3 The key issues.....	18
9.4 Weigh problem.....	19
9.5 Communication problem.....	19
9.6 Display problem.....	20
9.7 Error code.....	20
9.8 Other problems.....	20
10. The acceleration of gravity revised table.....	22

---

## Introduction

Thank you for choosing our hanging scale. In order to operate RLS correctly, the user manual is detailed in function and operation method of RLS, which help user with doubt quickly when come up against mechanical fault.

Rongta research, develop, produce and sale RLS independently, which is high-performance.

Hanging scale is the best choice for user in label printing business line with fashion appearance, power function and high durable, which make hanging scale more popular in store, fresh food supermarket, farmers market and so on.

**Note :** this product information are subject to change without prior notice.

This information is for reference only. In addition to China's existing laws and regulations, the company does not undertake any due to the direct or indirect losses caused by use of this information.

The company reserves the final interpretation.

---

---

# 1. The hanging scale's specification

- The Weighing range and accuracy.

RLS1315

Max weight: 15kg

Min weight: 40g

0kg to 6kg \* 0.002kg (e=2g)

6kg to 15kg \* 0.005kg (e=5g)

RLS1330

Max weight: 30kg

Min weight: 100g

0kg to 15kg \* 0.005kg (e=5g)

15kg to 30kg \* 0.010kg (e=10g)

- The accuracy grade: (III)

- Resolution:

Input sensitivity: greater than or equal to 50u V/D

Zero-point adjustment range: ±60MV

Temperature coefficient: ±0.0012%CTYP

[Zero] ±(0.2μV+0.0008% of Dead Load)/°CTYP

Nonlinearity: 0.01%F.S.

A/D resolution: Max 30000 resolution

Display resolution: 1/3000

A/D conversion rate: 6 times/second

- LCD display board:

Info/weight: 5byte(APHA)

Simple lattice: 8 byte

Total lattice: 8byte

Unit of weight: g. kg.

- Regular:

Power supply: 100V-240V~, 50/60Hz

Power consumption: Standby 3W, line printing 30W

Operating temperature: 0 °C~40 °C

Physical appearance: Length 388mm × width 343mm × high 985mm

## 2. Standard Equipment

- a. Host
- b. Tray
- c. Scale support - A
- d. Scale support - B
- e. Thermal label paper
- f. A Fuse , Six of M4 screw, A M5 hand the screw
- g. User Manual
- h. Serial cable
- i. Power cable

---

## 3. Features Summary

### 3.1 Unique and powerful network

- a. Use the Ethernet interface technology and the data transfer rate has been improved drastically.

### 3.2 Usage is easy to learn

- a. Operate the PLU by single bond to make fast sales, and the front desk staff could use it without training.
- b. 56 direct buttons and 112 hot buttons can be set up, and the common goods can be specified to hot buttons mostly.

### 3.3 Advanced functions and durable quality

- a. The under machine program can be upgraded by PC, the program will be the latest version and the function would be the most perfect forever.
- b. The design of the Printer structure is exquisite, is not easy to roll the paper.
- c. Barcode rotation could extend the lifetime of the print head.
- d. Having the function of weighing and pricing for the various packages, along with special designed barcode printing.
- e. Function: It can use a few goods to make up to platter, fruit basket, etc.
- f. Each PLU could be set to multiple tags.
- g. Each PLU could be used by separated barcode encoding formats, which could solve the encoding problem from distribution and consignment sales.
- h. Each PLU could use separated units.
- i. The unit of quantity could be self defined, such as block, packages, etc.
- j. PLU has abundant information, including barcode format, fresh code, package type, information provision, etc.
- k. Rotational printing the whole label.
- l. Support Ean-8, Ean-13 and 18 code, completely solving the problem of fresh commodities code.
- m. Unique bar code type to manage the fresh commodities by batch.

## 4. Hanging Scale Installation Steps

### 4.1 Installation

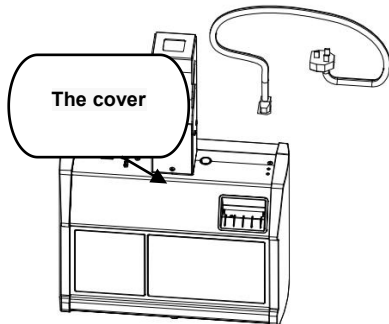

(1) Open the cover and connect the power plug from the top.

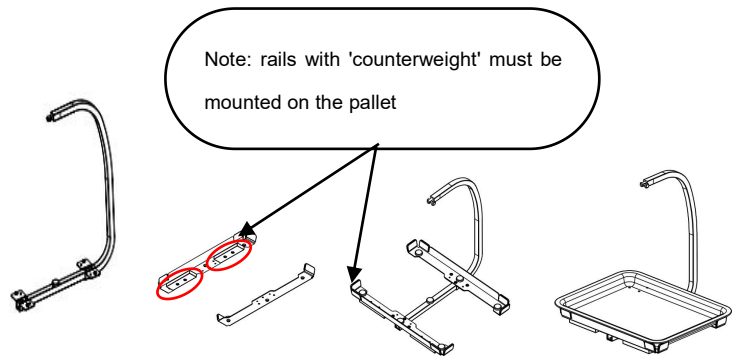

(2) Install scale beam accessories and place the tray.

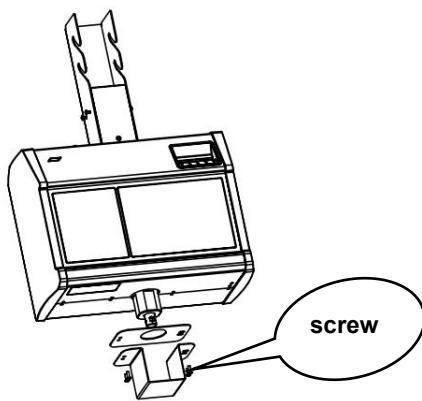

(3) Remove the sensor fixing support plate at the bottom of the scale body.

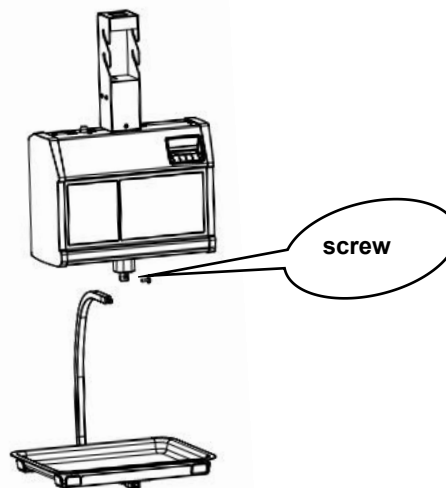

(4) Install the scale pan onto the scale body and tighten the screws.



(6) Installation finished.

## 4.2 The installation of the thermal label paper

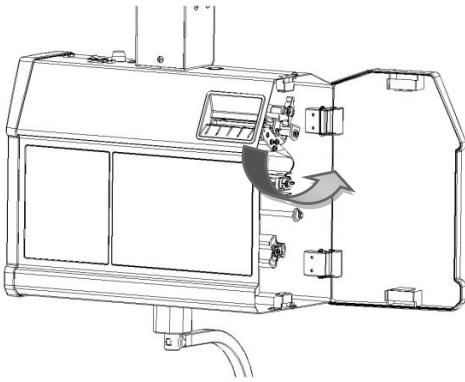

(1) Open the right side cover.

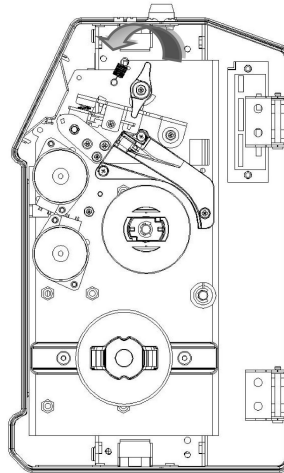

(2) Open the print head by counterclockwise rotate it.

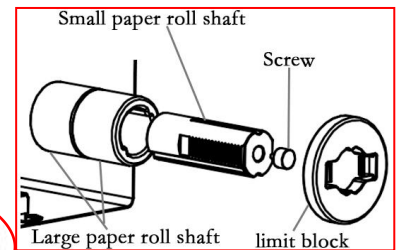
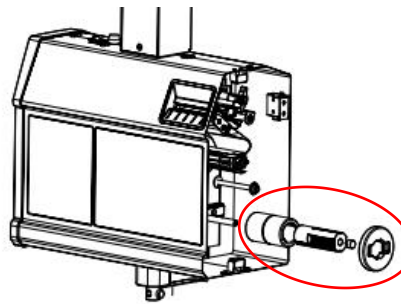
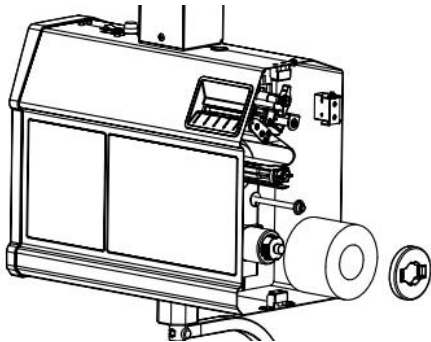

(3) Pull out the limit block to load the printing paper roll. To load a small paper roll, it is required to unscrew the screws, take out the paper shaft set and remove the two large paper roll shafts.

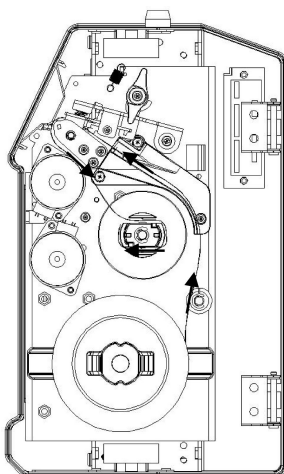

(4) Wind the paper according to the direction indicated by the arrow.

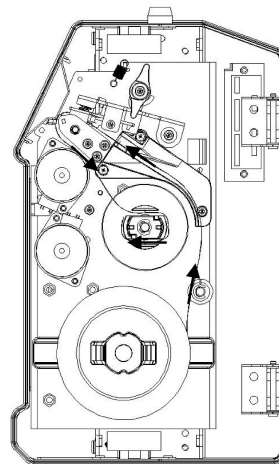

(5) Tear off the first few pieces of label paper and send the paper across the paper guide as indicated by the arrow.



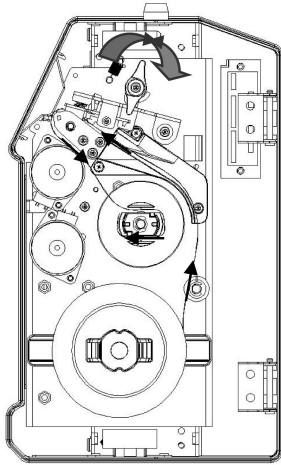

(6) Roll the front end of the paper roll around the filter plate into the recycled paper shaft according to the direction of the arrow, and close the print head

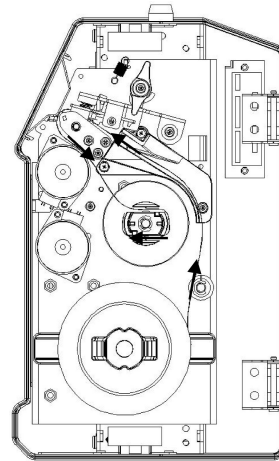

(7) Press [↑] key to wind the paper



(8) Install the paper stop pad and close the right cover.

### 4.3 Description of label paper

The label which is used at RONGTA hanging scale is: Thermal Seam Marking Label.  
As shown below:Height:60mm,width: (30~60)mm,Max outside diameter:100mm,  
Minimum inner diameter:40mm or 26.8mm .



inner diameter 26.8mm



inner diameter 40mm

## 4.4 The keyboard

Press [↑], [↓] button to adjust label position and long press [↑] button to align paper.

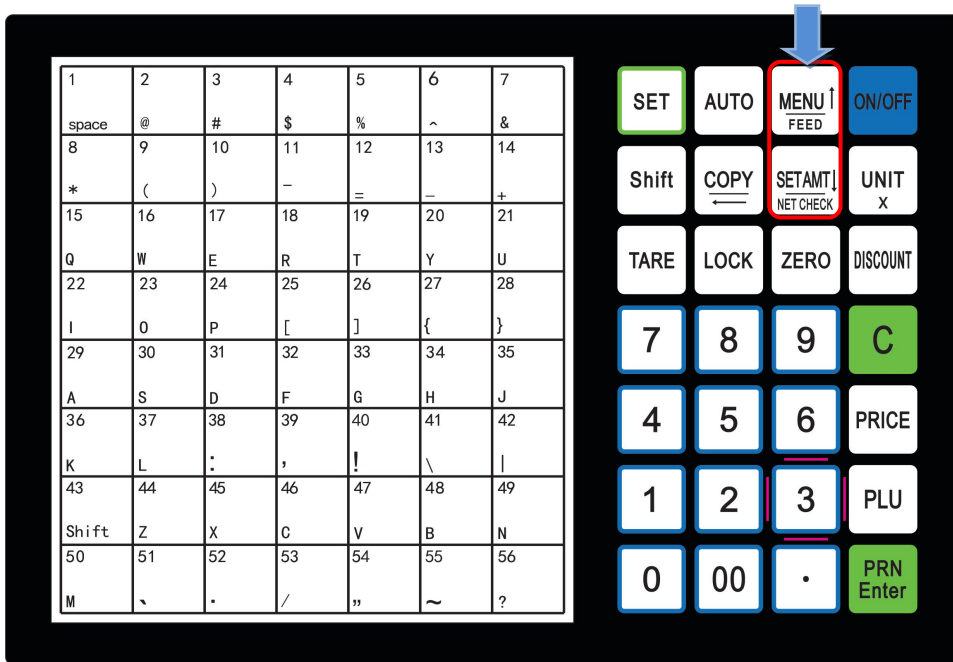

## 5. Overall Appearance

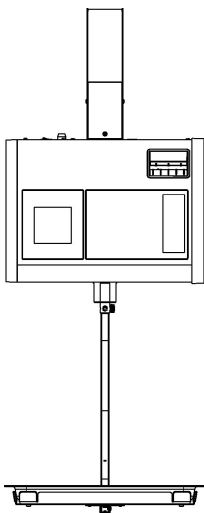

Front View

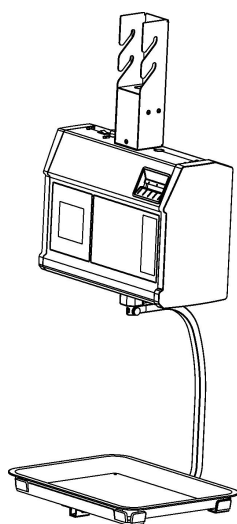

Left View

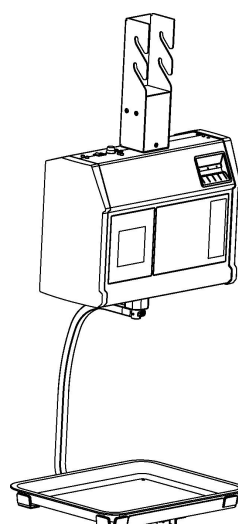

Right View

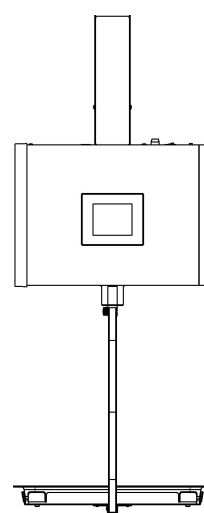

Rear View

## 6. Common easy-to-use operations

### 6.1 Switch on and off

Hard disk switch on/turn on: After connecting power supply, switch on the power button at the top of the hanging scale. After the screen shows one by one the information of edition No., IP address, self-test countdown “0、1、2、.....8”, the scale enter into sale pattern.

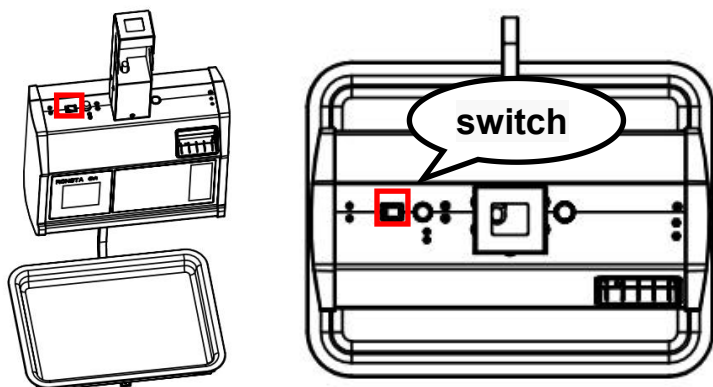

Vertical view 1

Vertical view 2

**Attention: under self-test situation, please do not press any button and make sure nothing is on the scale, otherwise it can't work normally.**

Soft disk switch on/off: Please switch on the power button, then press the button **[ON/OFF]** for 2 seconds.

### 6.2 Weighing and pricing

There are three methods for weighing and pricing. If the PLU information has been downloaded from PC or edited in the scale in advance, take the Method 1 and Method 2. If not, take the Method 3.

1. Under the “automatic printing” situation, once the weight is stable system will print label, if the weight and unit price is not zero showed.
2. When the “AUTO” arrow lights on screen, it means the system is in the state of auto printing. Press the **[AUTO PRN]** can switch the state. You can set whether to auto print or not when starting in the **[SETTING]**, the operation is according to the 8.2 system setting.
3. If nothing is on the scale tray or pressing the “zero” button even something on the tray and the light “zero point” is on, it means the scale is under zero point condition.
4. The following operations, including peeling, pricing with piece, discount and changing price, are based on automatic printing. If the scale is not under automatic printing condition (automatic printing light is off), you need to press the button **[PRN/ENTER]** for label printing.

#### Method 1: hotkey operation

Example: sale green onion 2kg. Suppose the hotkey is 1 and the unit price is €1.50/kg.

Operation procedure: press the button **[ZERO]** (if the screen already shows zero, the action can be slipped) put 2kg green onion on the scale tray → press the hotkey 1. Now, the relevant weight, unit price and total amount will be shown on the screen and the label will be printed. (PS : In the non-auto printing status, you need to press the key **[PRN/ENTER]**)

- 112 hotkeys in total and is changeable and can be printed by control PC.

- The above operation is suitable for hotkey 1-56; as for hot button 57-112, the operation is pressing the button **[PLU]** + the corresponding hotkey.
- For easy operation, all the PLU can print the latest illustration. The printing function is set by PC.

**Method 2:** general operation

Example: sale green onion 2kg. The Fresh Commodity Code is 10 and the unit price is €1.50/kg

Operation procedure: press the button **[ZERO]** (if the screen already shows zero, the action can be slipped), put 2kg goods on the scale ⇨ press the button **[PLU]** ⇨ input the LF code 10 ⇨ Press the button **[PLU]**. Now, the relevant weight' unit price, total price will be showed on the screen and the label will be printed.( PS : In the non-auto printing status , you need to press the key **[PRN/ENTER]**)

**Method 3:** suitable for not preset PLU(In the software setting function, select the "Num+ Amt print label ,print immediately ", then click downloading.)

## 6.3 Tare operation

The operation is just suitable for the goods need to be packed, e.g. egg, beans etc. There are two methods used for the following situation: 1.package and good separated; 2. Package and goods non-separated.

Method 1: suitable for package and good separated

Example: sale one box of apple. Suppose the apple's unit price is €6.0/kg, the hotkey is 05, and the weight is 2.0kg.

Operation procedure: put a container or package box supposed 1.0kg on the scale ⇨ press the button **[TARE]** ⇨ put on one box of apple ⇨ press apple's hotkey 05 ⇨ after weighting, take off the products and then press the button **[TARE]** again for elimination

Method 2: suitable for the tare weight known and the package and goods non-separated

Example: sale one box of apple. The unit price is €6.0/kg, tare weight 1.0kg, and the apple and box weighs 2.0kg in total.

Operation procedure: press the button **[ZERO]** (if the screen already shows zero, the action can be slipped) ⇨input the tare weight ⇨ Press the button **[TARE]** ⇨ put on one box of apple ⇨ press the hotkey 05 ⇨after weighting, press the button **[TARE]** again for elimination

## 6.4 Discount

Discount operation: The discount function can be locked via setting password through PC background server. Password can be changed through background at any time.

**Operation: Discount in proportion**

Example: Vegetable is priced at € 8.0 / kg and 5% off, and vegetable's hotkey is 12.

Steps: Enter discount 95% on the keypad ⇨ press button **[DISCOUNT]** ⇨ put the vegetables on scale ⇨ enter the hotkey 12.( PS : In the non-auto printing status , you need to press the key **[PRN/ENTER].**)

## 6.5 Price Changing

### 6.5.1 Permanent Changing

**Method 1:**

Example: before changing, apple's unit price is €4.00/kg, after changing, its unit price is €3.00/kg. And hotkey is 05.

---

Steps: press the apple's hotkey 05 ⇨ press button[PRICE] ⇨ input new price €3.00/kg ⇨ press button[PRN/ENTER] ⇨ weighing and pricing

**Method 2:**

Example: before changing, apple's unit price is €4.00/kg, after changing, its unit price is €3.00/kg. fresh commodity code is 15.

Steps: press button[PRICE] ⇨ input the apple's fresh commodity code 15 ⇨ press button[PRN/ENTER] ⇨ input new price €3.00/kg ⇨ press button[PRN/ENTER] ⇨ weighing and pricing

**6.5.2 Temporary Changing**

Example: before changing, cabbage's unit price is €1.40/kg, then temporarily changing to €2.00/kg. Fresh commodity code is 13.

Steps: put on 2.00kg cabbage ⇨ input the fresh commodity code 13 ⇨ press button[PRICE] ⇨ input new price €3.00/kg ⇨ press button[PRN/ENTER]

**6.6 Choosing Unit of Weight**

Method:

press and hold the button[UNIT] for 1 second (hear beeper) ⇨ choose new charge unit. e.g. choose "g" as unit and no operation for 2 seconds means confirm the new unit.

**6.7 Charging by Piece**

(P.S. for following operation, need to open the "charging by piece" function, with weight is 0 and turn off permanent price changing function. If using [NET CHECK/SET AMT] button, specified total amount function need to be ON.)

for single item-Method 1:

input relevant item's fresh commodity code (or press the hotkey) ⇨ (P.S.in the non-auto printing status, you need to press button[PRN/ENTER].)

for single item-Method 2:

input single item's price ⇨ press button[NET CHECK/SET AMT] ⇨ input relevant item's fresh commodity code (or press the hotkey) ⇨ (P.S.in the non-auto printing status, you need to press button[PRN/ENTER].)

for multiple items-Method 1:

input item's quantity(number) ⇨ press button[UNIT/X] ⇨ input single item's price ⇨ press button[NET CHECK/SET AMT] ⇨ input relevant item's fresh commodity code (or press the hotkey) ⇨ (P.S.in the non-auto printing status, you need to press button[PRN/ENTER].)

for multiple items-Method 2:

input single item's price ⇨ press button[NET CHECK/SET AMT] ⇨ input item's quantity(number) ⇨ press button[UNIT/X] ⇨ input relevant item's fresh commodity code (or press the hotkey) ⇨ (P.S.in the non-auto printing status, you need to press button[PRN/ENTER].)

---

## 6.8 Price Tag Printing

This operation is suitable for price tag printing.

Operation steps: Put the item on the scale  $\Rightarrow$  Select item or enter the price and print a label  $\Rightarrow$  Press **[copy]** and press the number key (1-9) to print 1-9 pieces of price tags. /Press **[copy]** and press the **[00]** to produce 1000 copies of the price tag. If you want to stop, press **[C]**

## 6.9 Quick Copy

Unlimited printing label function is fast and continuous printing same label.

Operation steps: Put the item on the scale  $\Rightarrow$  Select item or enter the price and print  $\Rightarrow$  Press **[copy]** and then press the number key **[0]** to do continue printing. (If you want to stop, press **[C]**)

## 6.10 Automatic fast packaging

This function can be applied to high-volume label of similar but different weight of the product.

Procedure: Activate the **[AUTO PRN]** and **[PRI LOCK]** function  $\Rightarrow$  choose a single product or enter a unit price  $\Rightarrow$  put the goods on the scale tray one by one, and the scale will start to print label automatically.

If when to operate fast, recommend to proceed as following procedure.

Procedure: Put item 1 on the scale tray, it will print label automatically  $\Rightarrow$  put item 2 on and take off item 1 take the label and stick it on item 1, next label will be printed automatically  $\Rightarrow$  put item 3 on and take off item 2  $\Rightarrow$  take the label and stick it on item 2, next label will be printed automatically  $\Rightarrow$  repeat the procedure, it can save time.

## 6.11 Operation button in common use

- Auto Print: Switch to automatic print, otherwise need to press button **[PRN / ENTER]** to print.
- Charge unit: Press button **[UNIT]** 2 seconds to switch charge unit €/kg or €/g.
- Price Locking: Press button **[PRI LOCK]** to continuously print label of same product (product name will not disappear). Press again to unlock.
- Price change: Press any hotkey  $\Rightarrow$  press button **[PRICE]** and input price.
- Discount: Enter the discount rate (e.g.: enter 80 for 80% discount) and press button **[DISCOUNT]** to calculate Enter hotkey of the goods  $\Rightarrow$  put good on the scale and start printing.
- Zero: press button **[ZERO]** to make zero of all the data.
- Peeling/Tare: weight the tare and press button **[TARE]**  $\Rightarrow$  put goods on the scale  $\Rightarrow$  enter corresponding hotkey  $\Rightarrow$  after printing, press button **[TARE]** to clear the tare weight.
- Clear: this button commonly used to clear the unit price and abnormal screen or an error message to keep the normal running of the system.

Setting: press button **[SETTING]** 3 seconds to enter Setting interface, where you can reset basic setting and parameters of the printer and scale. Such as IP setting, restore factory setting, print barcode type setting, WIFI setting, etc. Press **[↑]** **[↓]** button to select function setting, press confirm to enter setting interface, then set it.

**Note: when wrong operation cause system crash, need to restart the scale.**

---

## 7. Wireless Label Scale Setting Instruction

### 7.1 Network connection mode

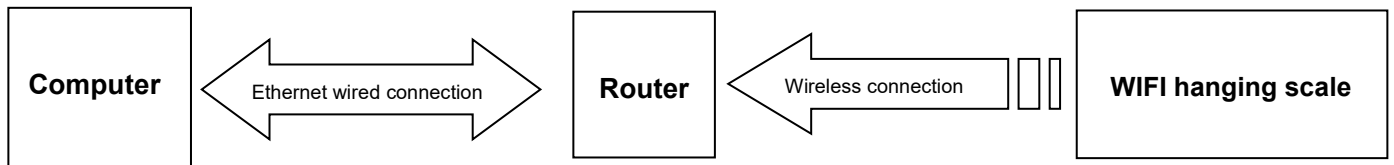

### 7.2 Router set up

1. Set the SSID name of the router. (No more than 15 characters.)
2. set the type of router's authentication, encryption algorithm, password,
  - Encryption type set as : WPA2-PSK
  - Encryption algorithm set as: AES
  - Password: no more than 15 characters

### 7.3 Hanging Scale Setting

1. Long press the set button, enter the settings menu.
2. Select IP settings, set the IP address of the label scale. (And need to be same network of routers which is the same IP address.)
3. Select "SET WiFi" menu.
4. Enter the SSID WIFI set menu: input router's SSID Name.
5. Enter the "WiFi password mode" select menu: select the WPA2-PSK/AES option. (need to be same as router encryption type.)
6. Enter the "WiFi password" setting menu, enter the router password. (the router password.)
7. After finish settings and restart the label scale, computer and label scale can be wireless communications.

### 7.4 Computer software settings

Set label scale corresponding to the IP address, after setting, Use software's "test network" icon for network testing, then connectivity can be normal communication, if it's failure, please check and make sure PC's IP address is in the same segment.

---

---

## 8. Function setting

- This function can be locked with a password. Password can be set and reset through PC.

### 8.1 Input settings of single item

**Step One:** press button **[PLU]** until screen shows "single item edit" to enter the edit mode.

**Step Two:** Type 6 digits of fresh commodity code and press button **[PRN/ENTER]** to confirm. When the screen shows "Product Name", enter price. (Meanwhile, can press **[↑][↓]** button to select the needed item, or enter corresponding letter shown in below sheet, if enter "N" means to edit item name.)

- **N** single item name: You can use the keyboard to enter the name of a single item, up to 36 digits.
- **L** single item Fresh Commodity code: Enter fresh commodity code within 6-digit.
- **C** single item Model: Enter Item No. within 10 digits.
- **P** Price: Enter the unit price of goods no more than 7 digits.
- **U** charge unit: Use button **[↑][↓]** to select g or kg.
- **F** Expiration: enter expiration date between 0~365.
- **T** Tare: Input tare weight within maximum.
- **B** Bar Code Type: Select the barcode type from 0-99.
- **D** department code: Enter the department code within 0-99.
- **W** Package weight: Enter PLU packaging weight.
- **Y** Package Type: Select packaging type with the left and right buttons (0: Normal, 1: fixed weight, 2: fixed price, 3: fixed weight & price).
- **E**: Package Tolerance: (0-20%).
- **M** Information 1: input selected information code. (0-197)
- **I** single item's label setting: 8 bits, 0: A0,1: A1,2: B0, 3: B1,4: C0,5: C1,6: D0,7: D1.
- **R** discount setting: (- 10 ~ -125) (- 10 ~ -1) corresponding to discount of type 10-1. (1 ~ 125) corresponding to a percentage discount.
- **S** Save for changes.
- **H** Hotkey setting: Up to three numbers, while preserving the changes of PLU.

### 8.2 System set up

- That operation can be lock by password. The password is set in PC and can be change at anytime.

Step 1: press **[set]** key and hold on 3s to enter system setting status.

Step 2: press **[↑][↓]** or direct number key accordingly to select item.

Step 3: press **[PRN/ENTER]** key to confirm.

Special note: In menu, 0=not, 1=yes, if others, will note.

Set menu items as below:

- **@** IP address: set IP address of hanging scale.
- **D** print density set: press **[↑][↓]** to select 0~7, from low to high, total 8 levels.
- **V** print speed set: press **[↑][↓]** to select 0~7, from low to high, total 8 levels.
- **S** select paper type: press **[↑][↓]** to select 0~3, total 4 types: 0:label,1:label,no recycle, 3:bottomless label.
- **A** paper position fine-tuning: press **[↑][↓]** to select -8~+8 , total 17 offset, adjust to most suitable



---

starting position.

- [↑]/[↓] Label style selection: D0 or D1 tag with / style [↑]/[↓].
- T date adjusting; set current date and time.
- N date format: set date format 0: DDMMYY,1: MMDDYY,2: YYMMDD.
- [↑]/[↓] whether to print weight unit: select to print weight unit or not.
- [↑]/[↓] whether to print price unit: select to print price unit or not.
- J decimal digits in unit price: set decimal digits in unit price.
- [↑]/[↓] set default barcode type: set barcode type(0~99, the details refer to appendix two in software user manual).
- X total price precision: set total price precision.(1: N.N0,2: N.NN,3: N.N)
- [↑]/[↓]total price carry set: set carry value.(for example round, that is 5.)
- W print time: set print time or not.(time format is hour and minute.)
- Y year digits: set year format.(0: YY,1: YYYY)
- G use after discount price or not: set barcode to print after discount price or not.
- [↑]/[↓] display items in weight field: set 0:weight, 1:quantity.
- Q print delete line mark: set 0: print, 1: not.
- [↑]/[↓] select barcode width: 0: wide, 1: narrow.
- E The supplementary of default information 1 :0 means not default information1.
- F The supplementary of default information 2 :0 means not default information2.
- [↑]/[↓] discount goods belong to special department: setting if discount goods belong to special department or not.
- R IP setting on the host machine: using this scale as the host machine to set IP address, to connect other scales.
- P statistics function mode: Choosing “yes” or “not ” to open statistics function mode for sales goods.
- [↑]/[↓] running account overflowing alarm: Alarming or not when the running account overflow.
- [ ↑ ]/[ ↓ ] summation printing: print summation label, total amount/total quantity/quantity of total label.(clicking twice (set)to set.)
- [↑]/[↓] sum all quantity of single goods' label: print all information of all sales goods.((clicking twice (set)to set))
- [↑]/[↓] clear all the summation data: clean up all the summation data.((clicking twice (set)to set))
- [↑]/[↓]fine tuning of paper-out position: adjust paper's offset value: 0~16.
- Z zero print: whether to start zero print price tag.
- [↑]/[↓] printing self test page or not: printing self test page or not.
- [↑]/[↓] auto printing: setting default auto printing when it open or not.

### 8.3 Lock

SETTING, PLU, DISCOUNT, PRICE, and TARE functions can be locked via pass code. Password of each function is independent, which can be set via pc software then download to each scale, and it can be change at any time. more details please check the security item in the function setting II which is in the software operating instructions .

- **Open (before shutdown by software, Function after opening is always valid)**

Open ⇨ choose the function you would like to open

---

For example:

#### **Open “SETTING” function**

Click **[SETTING]** key for 2 seconds to come into the system setting status, system remind that enter pass code, it means that entering the pass code which is set via pc software.

#### **Open “PLU” function**

Click **[PLU]** key for 2 seconds to come into the PLU editing status, system remind that enter pass code, it means that entering the pass code which is set via pc software.

#### **Open “DISCOUNT” function**

Click **[DISCOUNT]** key for 2 seconds to come into the discount status, system remind that enter pass code, it means that entering the pass code which is set via pc software.

#### **Open “PRICE” function**

Click **[PRICE]** key for 2 seconds to come into the price setting status, system remind that enter pass code, it means that entering the pass code which is set via pc software.

#### **Open “TARE” function**

Click **[TARE]** key for 2 seconds to come into the tare setting status, system remind that enter pass code, it means that entering the pass code which is set via pc software.

#### ● **Restored lock**

Click **[ON/OFF]** key for 2 seconds to turn off the scale ⇨ click **[ON/OFF]** to turn on the scale

## **9. Troubleshooting**

### **9.1 Scales crash**

#### ● Boot up without any response.

Reasons:

- a. Bad contact between the power plug and socket.
- b. The power cord is disconnected.
- c. Filtering group Fuse is disconnected.
- d. Transformer is broken.
- e. Motherboard is broken.

Solutions: use millimeter to check them one by one, use method of exclusion to find the solution.

#### ● Boot up without any sound, No display,backlight.

Reasons: the spark generated by the power plug impact the program.

Solutions: Replace the Motherboard, reset the number, and download all the files.

#### ● Boot up without any sound, display “Update”.

Reasons:

- a. Program downloads error.
- b. Misoperation during the downloading of the program. (such as halfway power outage.)

Solutions:

- a. Reload the correct procedures.Setting IP (default is 192.168.1.87),when update by Ethernet. And if update by serial port input any number as the scale's ID. ( the max baud rate is 115200. )
- b. Ditto.

---

## 9.2 Print related issues

- Print a blank label, paper orientation is normal.

Reasons:

Setting label type error. Usually the label type computer download is D0, so label type of hanging scale printing should be set D0. Or the printed label is blank.

Solutions:

a. Adjust the settings in following key order. (on the scale.)

[SETTING] ⇨ Enter the system setting ⇨ Press hotkey[ L ] ⇨ Enter the select label type (0: D0; 1: D1) ⇨ Press [PRN/Enter]

b. It's also available to adjust software on computer. Open hanging scale RLS1000, input serial number of the scale. Change label type to D0 in set function, then carry out function set command.

- Print half or a half label, paper orientation is abnormal.

Reasons:

a. Set paper type detection error.

b. Printer rear photoelectric has slanting direction or is dust.

c. Photovoltaic panels was damage.

d. Photoelectric pair of printer rear photoelectric is bad.

Solutions:

a. Adjust the settings in following key order on the scale.

[SETTING] ⇨ Enter the system setting ⇨ Press hotkey[S ] ⇨ Enter the select label type (0: label; 1: receipt 2: label, without recycle paper roll) ⇨ Press [PRN/ENTER]

It's also available to adjust software on computer. Open hanging scale RLS1000, set paper type to "Label" in set function, the pass the setting to error scale.

b. Check whether printer rear photoelectric has slanting direction or is dust.

c. If the problem still can't be solved, consider changing photoelectric pair. It is better to handle this step by professional person of our company.

d. Wash the rubber roller.

*Wash the rubber roller pictures show:*

1. Loose switch wrench and recycle paper spring, disboard print paper.

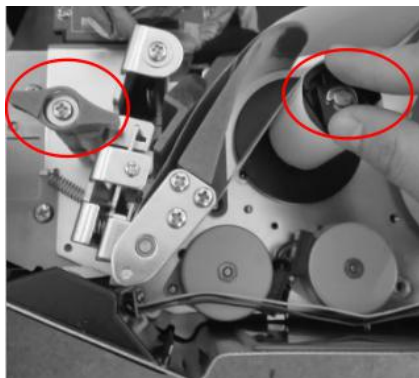

- Set label scale as paper feed menu, long press paper feed menu and let rubber covered roller in idle status.

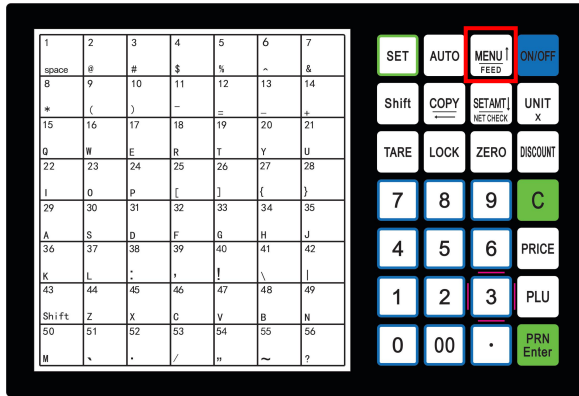

- Take a clean cotton swab dipping alcohol and cleaning the roller back and forth.

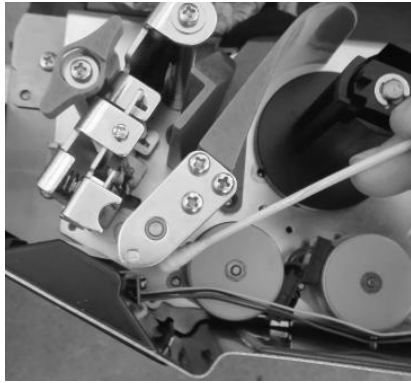

- Fuzzy print and it is not black enough.

Reasons:

- Printer head has not been fasten well.
- Thermal head is dirty.
- Print density is too low.

Solutions:

- Re-fasten the printer head well.
- Wipe the thermal head with a soft cloth glued alcohol gently.
- Increase print density.

- Print a label with half clear and half fuzzy or even blank.

Reasons:

- Printer head has not been fasten well.
- Thermal head is dirty.
- The print head deformation.

Solutions:

- Re-fasten the printer head well.
- Wipe the thermal head with a soft cloth glued alcohol gently.
- If the problem still can't be solved by above method, then cause of the error is the print head deformation, need to change printer. Bad printer should be handled by professional person of our company.

Wash the thermal head pictures show:

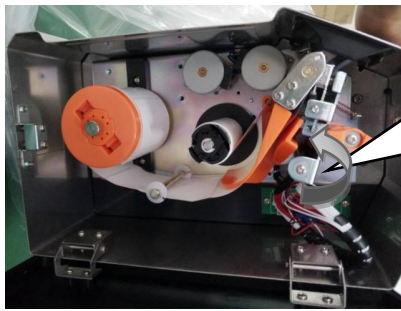

Turn the orange handle counterclockwise and open the print head



Dip in with soft dry cloth to wipe the small amount of alcohol thermal head

- Weird character show on label or character can't be printed out(including Chinese and English)

Reasons:

- a. Haven't download fonts or single-byte character.
- b. Font conflict.

Solutions:

- a. Re-download fonts. (including single-byte and double-byte character.)
- b. Re-select single-byte and double-byte fonts by files/option/hanging scale fonts, then download Chinese and English fonts.

### 9.3 The key issues

- Keys have been ringing, display is normal

Reasons:

- a. Line piece of key cause short circuit.
- b. Sharp object resist the key.

Solutions:

- a. Change line piece of the key.
- b. Move the sharp object.

- Some keys do not ring

Reasons:

- a. The ribbon cable connected between the key board and the mother board is not plugged in.
- b. The Mylar button FPC ribbon cable is not plugged in.
- c. The key is damaged.

Solutions:

- 
- 
- a. Check out key ribbon cable, re-insert properly.
  - b. The Mylar button FPC ribbon cable is re-plugged in or pulled out.
  - c. If the problem still can't be solved by above method, then maybe the key is damaged, change it.

## 9.4 Weigh problem

### Weigh inaccurately

Reasons:

- a. Damp, module aging, or regional differences to make the weigh inaccurately.
- b. The load cell damaged due to the overload.
- c. Not adjust the Gravitational acceleration.

Solutions:

- a. Leaning the Zero/Full weigh again. Replace the mainboard, AD board, even load cell if the problem could not be solved.
- b. Replace the load cell and support frame.
- c. Adjust the Gravitational acceleration.

**PS:** Generally, the scale should be returned back to our company due to the problems of AD board and load cell.

### Zero point instability

Reasons:

- a. Environmental impact, such as vibration, wind or strong magnetic interference.
- b. Weighing electric circuit gets damp.
- c. The wind resistance function has not opened.

Solutions:

- a. Exclude the interference factors.
- b. Replace the mainboard.
- c. Open the wind resistance function.(set it in function set)
- d. If still not, return back the scale to our company.

### Unable to weigh

Reasons: Bad mainboard, bad AD board or bad load cell.

Solutions:

- a. Replace the mainboard.
- b. Check the AD board is OK, or not, return back to our company if this problem could not be solved.

## 9.5 Communication problem

### Unable to communicate

Reasons:

- a. Communication ports are set up incorrectly.
- b. The incorrect serial number of scale, or the incorrect IP address.
- c. The incorrect connection of interface, or problem on Ethernet cable.
- d. The error on power board or mainboard.

---

Solutions:

- a. Confirm the available communication ports.
- b. Confirm the same serial number in scale , and same IP address in scale.
- c. Please replace mainboard or power board to confirm the error,  
if there are not the problems mentioned above.

## 9.6 Display problem

- **No display or display but without characters**

- a. The terminals are not connected well.
- b. The plug and socket are not connected well.
- c. The display is damaged.

Solutions:

- a. Check if the terminals are damaged or reconnect the terminals.
- b. Re-check the plug and socket.
- c. Replace the display.

## 9.7 Error code

- Er-01: Total Price Over
- Er-02: Label Height Over 90mm
- Er-03: None Label to Be Copy
- Er-04: NO Find Label Gap
- Er-05: Weight Error
- Er-06: The PLU NO Sale Date
- Er-07: Price Can Not Be Zero
- Er-08: Please Exit Tare Mode
- Er-09: Salesman Err
- Er-10: Please Close Orange Handle
- Er-11: Wrong LF code or PLU Not Exist
- Er-12: Weight Not Change
- Er-13: NO Paper
- Er-14: -----(Weight Over)
- Er-15: Take Out Label
- Er-16: PLU is not Defined on Hotkey

## 9.8 Other problems

- **Print paper difficultly, paper roll fixed.**

Reasons: Maybe the mismatch between paper roll and shaft, or the wrong installation of shaft.

Solutions: It is better to return this printer to factory for reinstallation.

- **“KaKa” sound when printing, don’t feed paper(note: if appear this problem, please don't press "print" button, otherwise may burn out main board)**

Reasons:

- a. paper installation is not correct, cause paper jam.

- 
- b. paper receiving shaft jammed.
  - c. there is stuff between small gear and big gear.

Solutions:

- a. reinstall paper correctly.
- b. reinstall paper receiving shaft.
- c. check gear, remove stuff.

- **Press PLU hotkey sometimes don't print, but the keyboard response**

Reasons:

- a. He tray is unstable.
- b. No download PLU data to the scale.
- c. There is still label paper in the printer, did not take away in time.

Solutions:

- a. Hang the label scale horizontally to ensure that it is in a horizontal position.
- b. Download all PLU data to scale from the software.
- c. Take away label paper in time.

- ☺ The failures listed above involving the handle of mainboard and sensors, the replacement of the print head, printer, photocell, etc hardware should return to the company and handled by the professional staffs in principle.
- ☺ Fault can't be solved as above solutions, should return to the company and handled by professional staffs.
- ☺ There is two communication ports in label printing scale, they are RS232 and TCP/IP(Ethernet), RS-232 type is optional.



## 10. The acceleration of gravity revised table

COUNTRY	CITY	G(m/sec <sup>2</sup> )	COUNTRY	CITY	G(m/sec <sup>2</sup> )
Greece	Athens	9.800	Scotland	Glasgow	9.816
South Africa	Cape town	9.796	Spain	Madrid	9.800
Netherlands	Amsterdam	9.813	Singapore	Singapore	9.781
Norway	Oslo	9.815	Argentina	Buenos Aires	9.797
New Zealand	Auckland,NZ	9.799	United Kingdom	London,Greenwich	9.812
New Zealand	Wellington,NZ	9.801	Australia	Melbourne	9.800
Taiwan	Taichung	9.789	Australia	Sydney	9.797
Taiwan	Taiwan	9.788	Italy	Milano	9.806
Taiwan	Taipei	9.790	Italy	Rome	9.803
Denmark	Copenhagen	9.815	India	Calcutta	9.788
Germany	Frankfurt	9.810	Japan	Tokyo	9.798
Mexico	Mexico City	9.779	Canada	Ottawa	9.806
U.S.A	Birmingham	9.813	Canada	Vancouver,BC	9.809
U.S.A	Chicago	9.803	Cuba	Havana	9.788
U.S.A	Los Angles	9.796	Kuwait	Kuwait	9.795
U.S.A	New York	9.802	Cyprus	Nicosia	9.797
U.S.A	San Francisco	9.800	Thailand	Bangkok	9.783
U.S.A	Washington,DC	9.784	Portugal	Lisbon	9.801
Belgium	Brussels	9.811	France	Paris	9.809
Brazil	Rio de Janeiro	9.786	Finland	Helsinki	9.819
Sweden	Stockholm	9.818	Philippines	Manila	9.784
Switzerland	Zurich	9.807			

- It should be handled by person in our company or dealers if want to adjust acceleration of gravity.



**Rongta Technology (Xiamen) Group Co., Ltd.**

**ADD: No. 889 Xinmin Avenue, Tongan District, Xiamen, China**

**WEB: [www.rongtatech.com](http://www.rongtatech.com)**

**TEL: 0086-592-5666129    FAX: 0086-592-5659169**

